

Article number: 204040M1231A1X

Description: E+G levelling foot
GN 40-40-M12-31-A1-X

Note: X With female thread, External hexagon

Measures

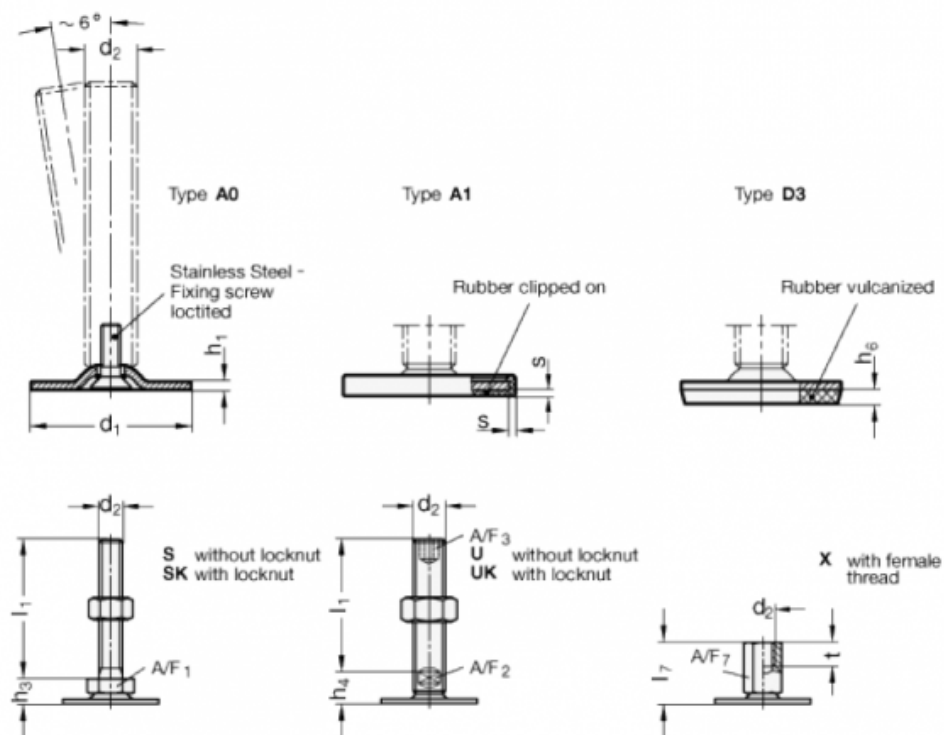

A/F7	=	17
d1	=	40
d2	=	M12
h1	=	2
h6	=	
l7	=	31
s	=	1.5
t	=	12